

WMA 4

Weight: 12 LBS.

The arm shall be of one piece unitized aluminum construction, fully welded and assembled. The back plate shall be one piece cast aluminum. The arm shall be prewired with a quick connector for easy installation.

The arm shall have a cast aluminum fitter welded to the top of the arm(s) for attaching the fixture. The fixture shall be mounted with three stainless steel bolts through the top of the arm fitter into the fixture. The attachment point shall have a silicone pad for sealing the fixture to arm connection.

Mounting hardware and J-box by others.

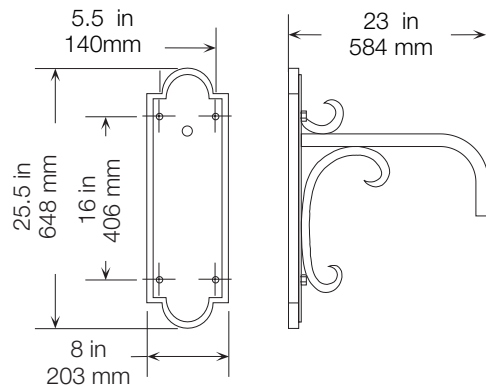

Note: Back plate is welded to the arm.

SOLD TO	PO #	JOB NAME
	/	/

APPROVALS

Architectural Area Lighting

16555 East Gale Avenue | City of Industry | CA 91745

Tel: 626.968.5666 | Fax: 626.369.2695 | www.aal.net